

### Rigid Pass Through

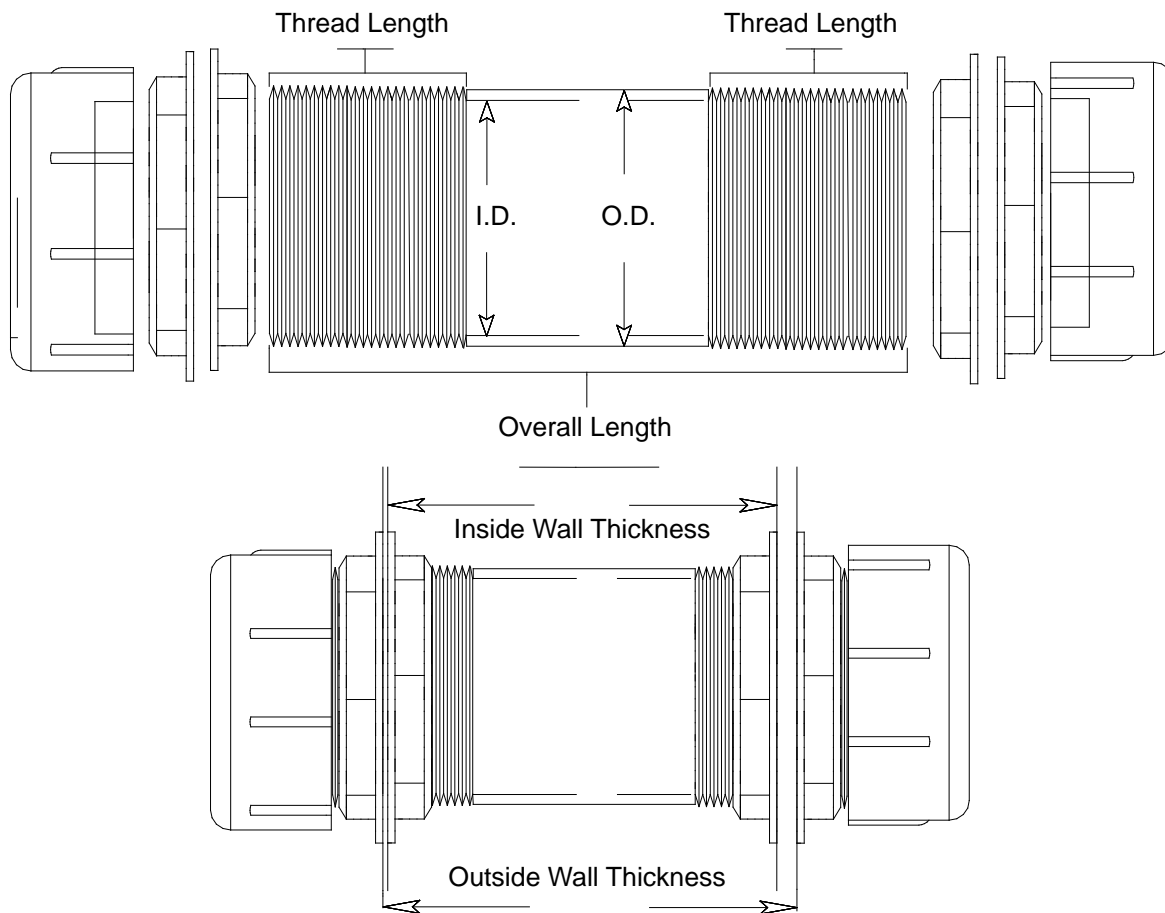

Please check box for cap style and pass through size.

Closed Cap

Gasketed Cap

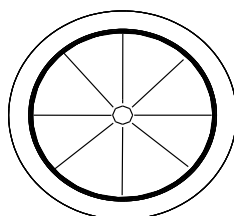
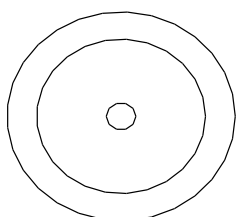

These are inside dimensions

- 1-1/2" pass through
- 2" pass through
- 3" pass through
- 4" pass through
- 6" pass through

## Bench Top Sleeve

W38576-200 - 2"

W38576-301 - 3"

This sleeve is used to penetrate the top of a cabinet so that vacuum hoses and other fragile piping can be brought out of the cabinet through the top without cutting or chafing the hose.

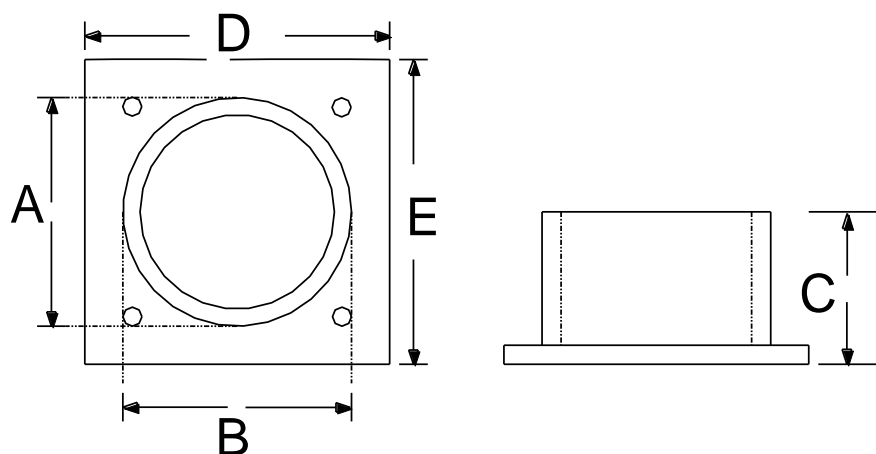

SYMBOL	A	B	C	D	E
W38576-301	3."OD	3."OD	2.25"	5."	5."
W38576-200	2."OD	2."OD	2.25"	5."	5."

\*\*\*Please specify 2" OR 3" OD upon order\*\*\*

LC38580-200  
2" Flex Pass Through

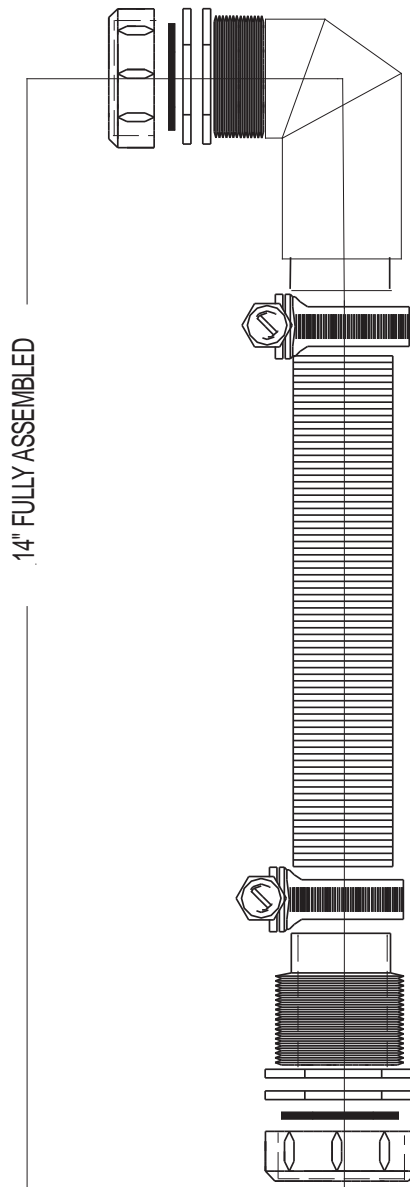

T-W38547-300(closed cap)

T-W38548-300(serrated cap)

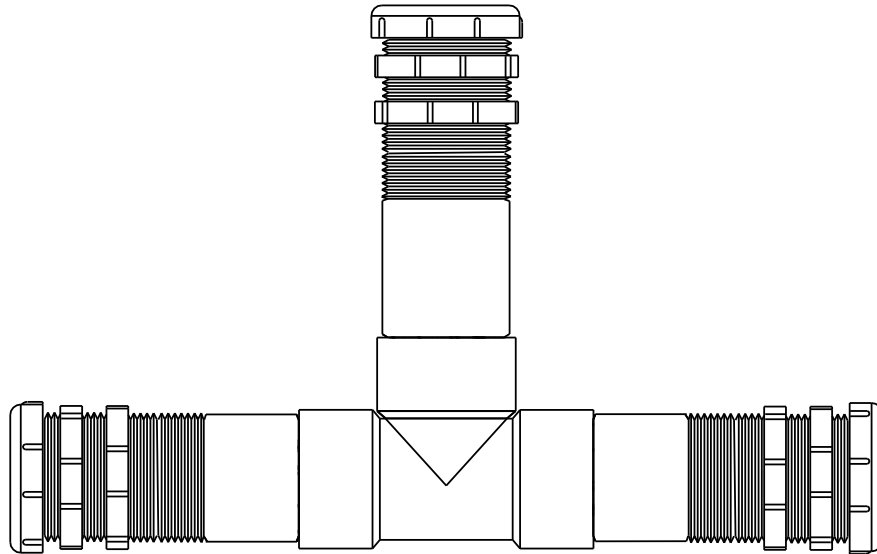

Please check box  
for cap style and  
pass thru size.

Closed Cap

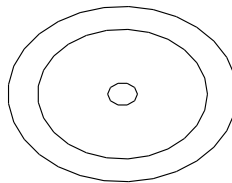

Serrated Cap

